

REV.	DATE	ECN NO.	MODIFICATION	APPROVER
A0	2021.04.26	/	NEW	Abel

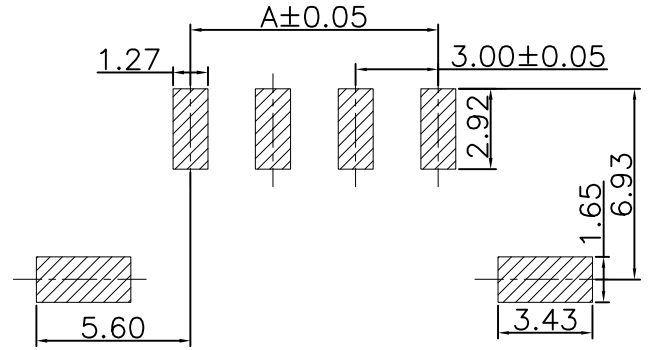

SPECIFICATIONS:
Material:
 1.Housing:LCP ,black UL94V-0
 2.Contact:H62,Matte tin 80u"min plated over Ni 30u"min
 3.Solder tab:H62,Matte tin 80u"min plated over Ni 30u"min
Electrical:
 1.Current Rating:5A AC
 2.Voltage Rating:250V AC/DC
 3.Contact Resistance:20mΩ Max
 4.Dielectric Withstanding Voltage: 1000V AC
 5.Insulation Resistance: 1000MΩ Min
Environment characteristics:
 1.Operating Temperature:-25°C~+85°C
 Major Dimension:▼
 Products meet RoHS environmental requirements

RECOMMENDED PCB LAYOUT
 TOLERANCE:±0.05

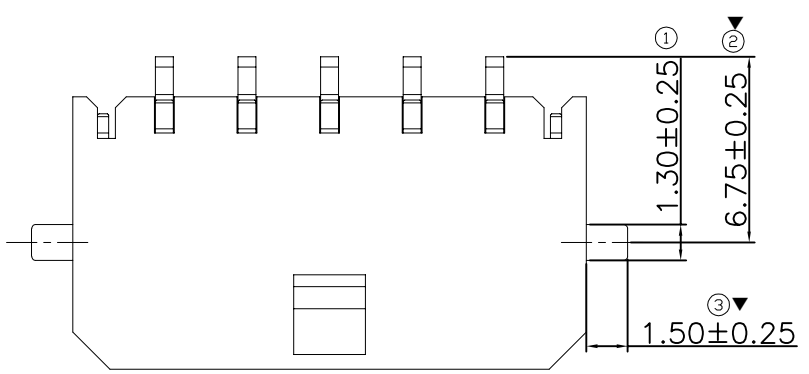
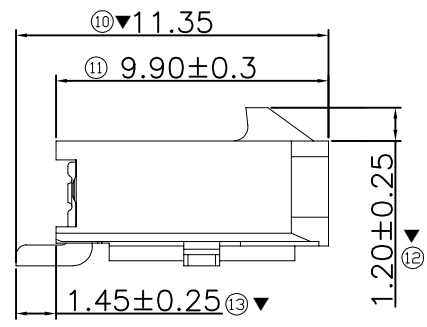
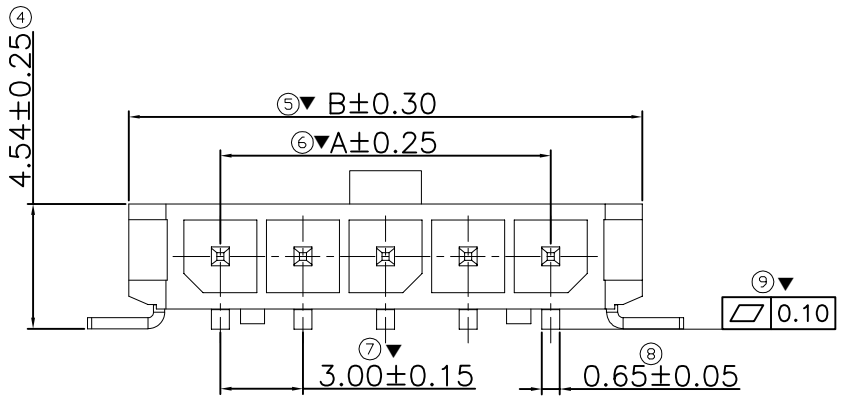

PIN NO	Dimensions (mm)	
	A	B
2P	3.00	9.65
3P	6.00	12.65
4P	9.00	15.65
5P	12.00	18.65
6P	15.00	21.65
7P	18.00	24.65
8P	21.00	27.65
9P	24.00	30.65
10P	27.00	33.65
11P	30.00	36.65
12P	33.00	39.65

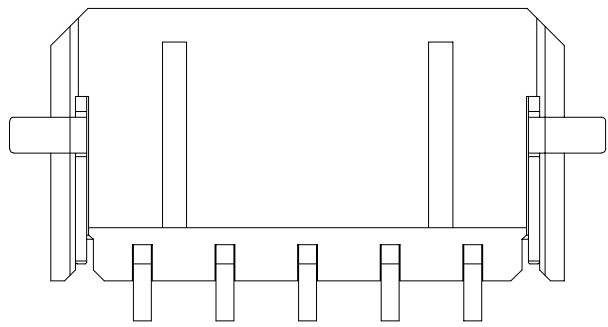

GENERAL TOLERANCE			
SELECT	✓		
TOL.	1	2	3
ON.	X.XXX	X.XX	X.X
	±0.10	±0.15	±0.20
	±0.15	±0.20	±0.25
	±0.20	±0.25	±0.30
	±0.25	±0.30	±0.50
ANGLE	±2°		

UNITS	mm
MAT'L	WF
FINISH	
Q'TY	
NAME(INTENDED USE)	WF
PART NO.(INTENDED USE)	WF300**--26***
APPD:	Abel
CHKD:	Vicky
DR:	CHENG

ATOM® 深圳市爱特姆科技有限公司
 SHENZHEN ATOM TECHNOLOGY CO., LTD.
 TITLE: Customer Drawing For Wafer3.0mm XP SMT 贴片
 DWG NO.: ATOM-A09857
 SCALE: 1:1
 SHEET: 1/2
 REV: A0

5	6	7	8
REV.	DATE	ECN NO.	MODIFICATION
AO	2021.04.26	/	NEW
			APPROVER
			Abel

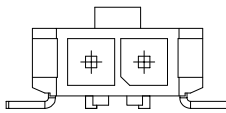

2PIN

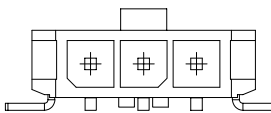

3PIN

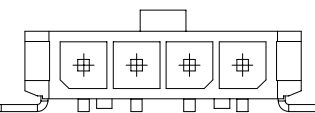

4PIN

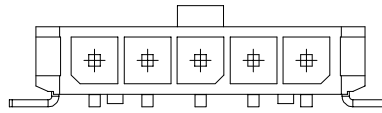

5PIN

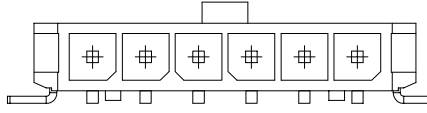

6PIN

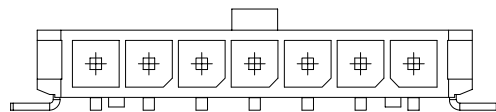

7PIN

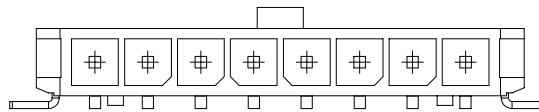

8PIN

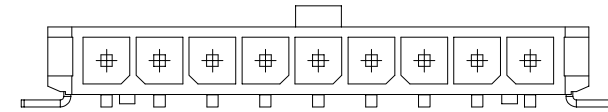

9PIN

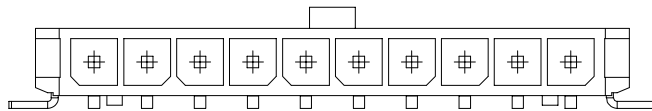

10PIN

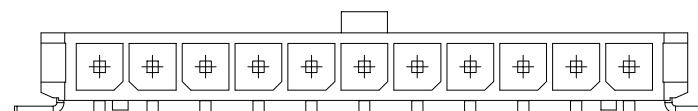

11PIN

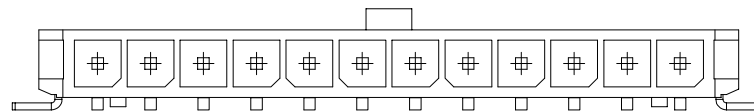

12PIN

GENERAL TOLERANCE			UNITS mm	NAME(INTENDED USE) WF	ATOM ® 深圳市爱特姆科技有限公司 SHENZHEN ATOM TECHNOLOGY CO., LTD.			
SELECT	✓							PART NO.(INTENDED USE) WF300**--26***
TOL.	1	2	3	APPD: Abel	DWG NO.: ATOM-A09857			
ON.	X.XXX	±0.10	±0.15					±0.20
	X.XX	±0.15	±0.20	±0.25	DR: CHENG			
	X.X	±0.20	±0.25	±0.30				
	X.	±0.25	±0.30	±0.50				
ANGLE	±2'							